



MTS Sprocket: 15T, Large Hub



Assembly Guide (RB-Lyn-919)



V1.0 August 2016

STEP 1: Connect hub and sprocket walls

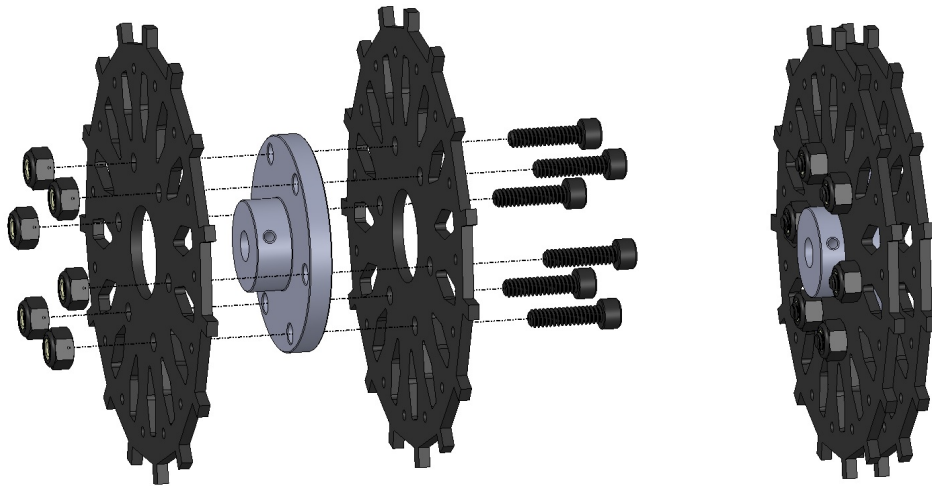
			
1x	2x RB-Lyn-905	6xRB-Mcm-59	6x RB-Mcm-60
Large Hub	15T-Lexan-L	10-24x3/4" SHCH	10-24x3/8" LN



STEP 2: Attach teeth

		
15x RB-Skj-01	15x RB-TeX-20	15x RB-TeX-12
MTS Tooth	4-40x5/8" SHCS	4-40x1/4" LN

