





MTS Sprocket: 12T, 6mm Small Hub



Assembly Guide (RB-Lyn-911)

V1.0 August 2016

STEP 1: Thread set screw into hub

	
1x RB-Ama-01	1x RB-TeX-48
6mm Hub	10-32 x 1/4" Set S

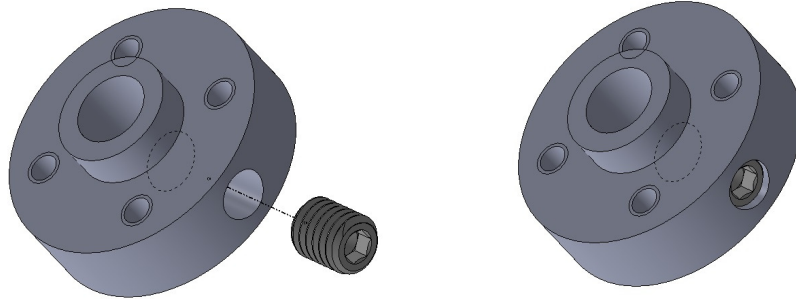

STEP 2: Connect hub to sprocket wall

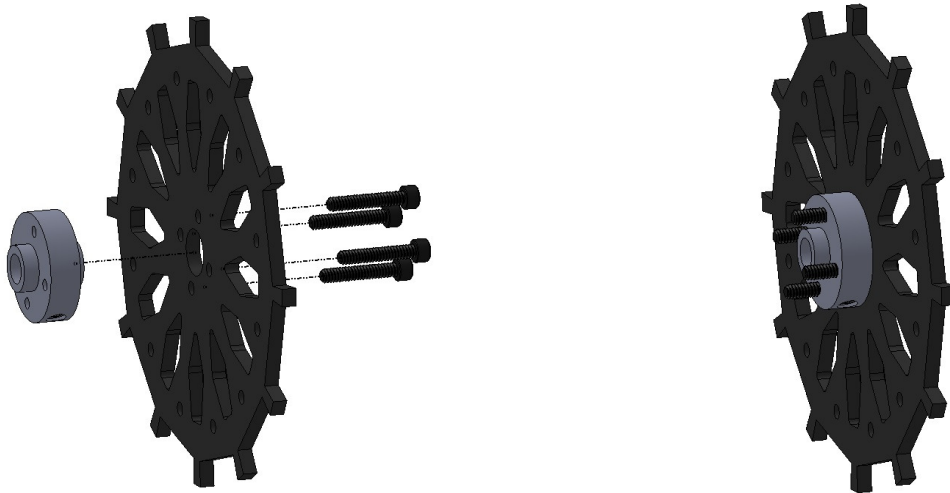

		
1x RB-Lyn-908	4x RB-TeX-20	4x RB-TeX-12
12T-Lexan-S	4-40x5/8" SHCS	4-40x1/4" LN

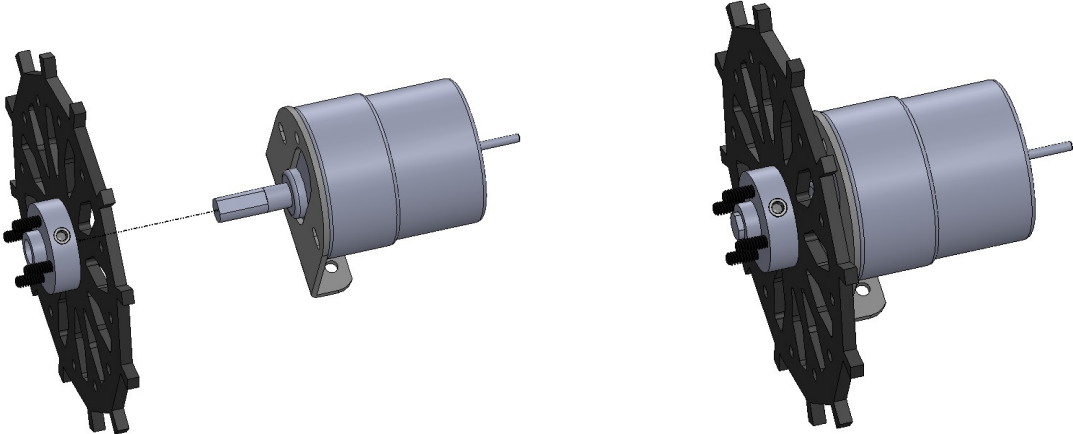

STEP 3 (optional): Connect sprocket sub-assembly to motor shaft & secure set screw to flat



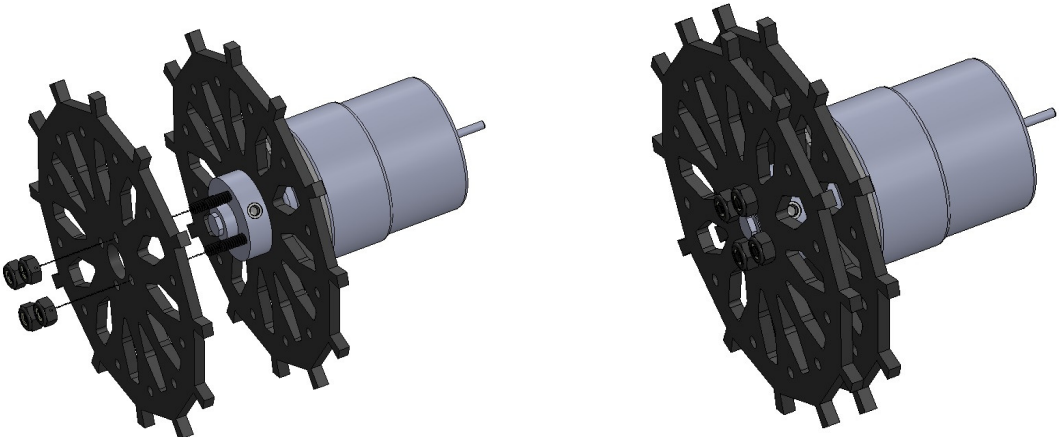

STEP 4: Add second sprocket wall

	
1x RB-Lyn-908	4x RB-TeX-12
12T-Lexan-S	4-40x1/4" LN



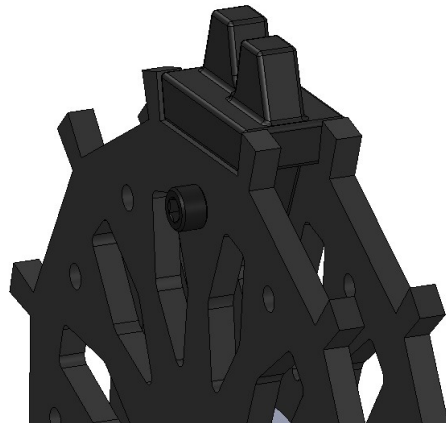
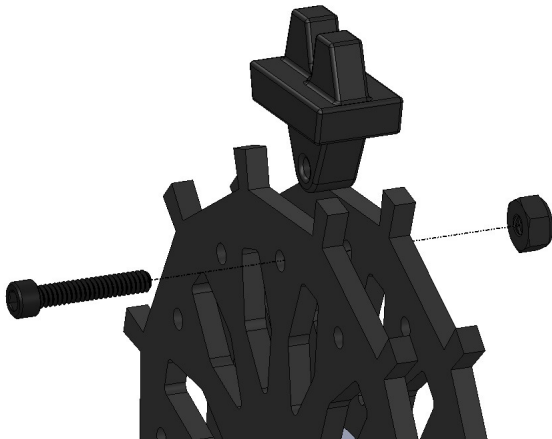

STEP 5: Attach tooth

		
1x RB-Skj-01	1x RB-TeX-20	1x RB-TeX-12
MTS Tooth	4-40x5/8" SHCS	4-40x1/4" LN



STEP 6: Attach remaining teeth

		
11x RB-Skj-01	11x RB-TeX-20	11x RB-TeX-12
MTS Tooth	4-40x5/8" SHCS	4-40x1/4" LN

